

Single sided safety barrier for bridge

# TR H2-W4 bw

CE 610/2131/CPR/2017

# KISAN

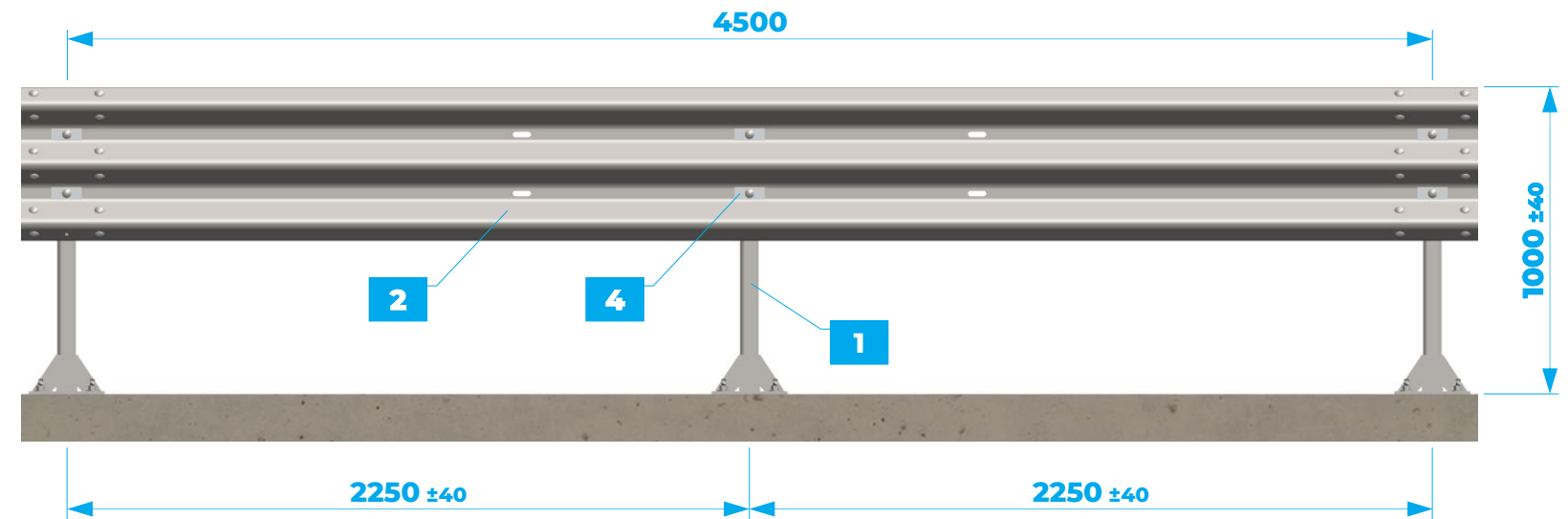
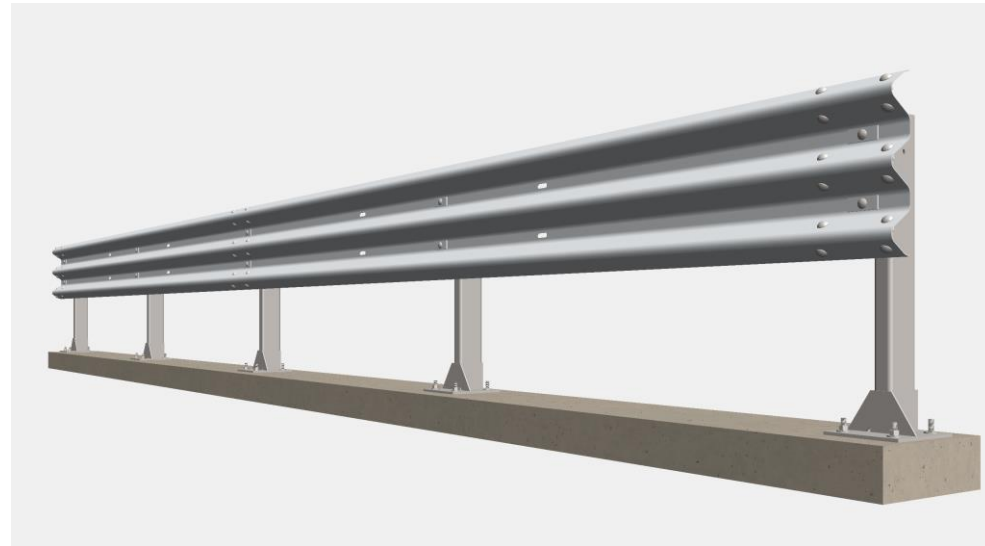

### Characteristics

Height above ground	1.000 mm
Depth of anchor rods penetration	150 mm
Overall width	287 mm
Post spacing	2.250 mm
Modularity	4.500 mm

### Performance EN 1317

Test TB11, car, 900kg, 100km/h, 20°	Aisico #1491
Test TB51, bus, 13.000kg, 70km/h, 20°	Aisico #1492
Installation length	54 m
Containment level	H2
Severity impact	B
Normalised working width	W4
Normalised dynamic deflection	1,2 m
Normalised vehicle intrusion	VI5



#	Component	Galvanized	Corten
1	Post with footplate, C120, 915 mm, 5,00 mm	S355 JR	S355 J0W
2	Beam, 3W profile, 4.800 mm, 2,50 mm	S355 JR	S355 J0W
3	Spacer, U80, 290 mm, 3,00 mm	S355 JR	S355 J0W
4	Connection plate, M16, 100 mm, 5,00 mm	S235 JR	S355 J0W
5	Connection plate, M12, 100 mm, 5,00 mm	S235 JR	S355 J0W
6	Round head bolt M16x35, nut, washer	8.8	Tropicaliz.
7	Round head bolt M16x45, nut, washer	8.8	Tropicaliz.
8	Hexagon head bolt M12x40, nut	8.8	Tropicaliz.
9	Anchor rod M16x200, nut, washer	8.8	Tropicaliz.

